

**RoHS Compliant & Pb Free Product**

**MC1-SW04A:**

- Category: Switch
- Device Package: MSOP-8G
- Cell Size: Single (1x1)
- PCB Material/Layer Details: RO4350/Single layer with thickness 0.020"

**Supported Device Package and Its Pin Allocation:**

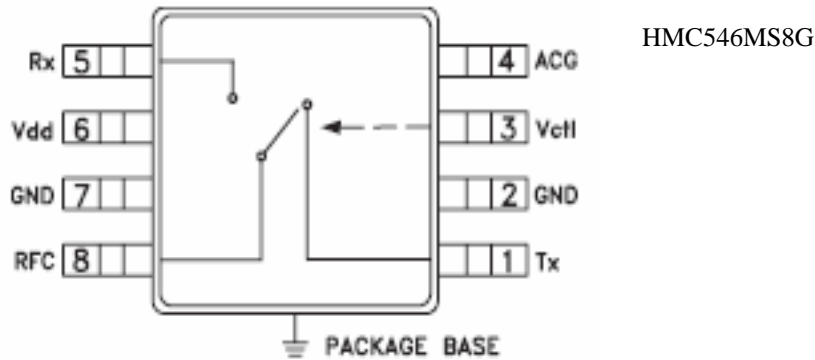

**Schematic:**

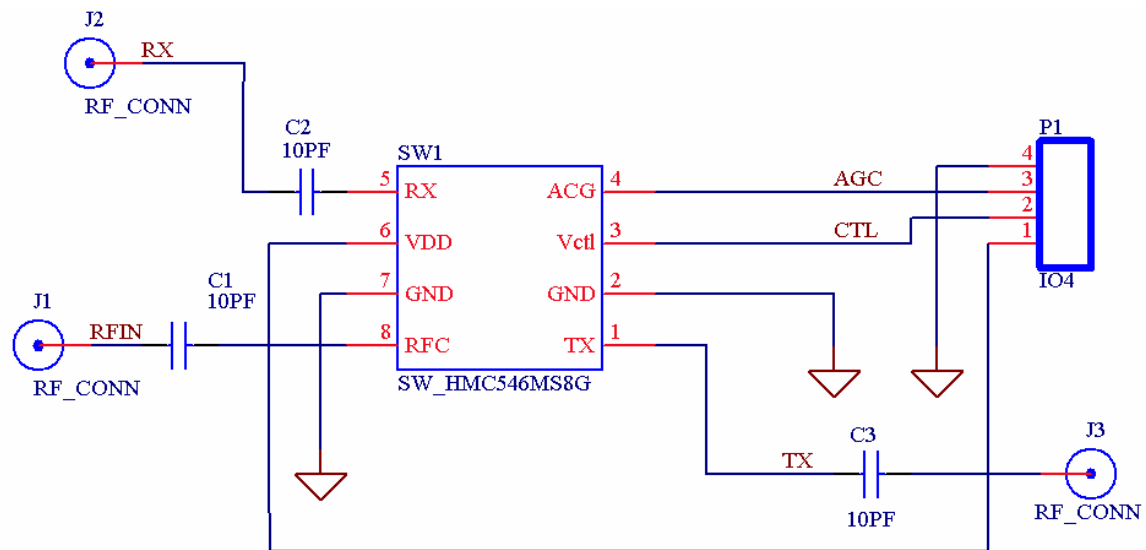

**MC1-SW04A PCB Layout:**

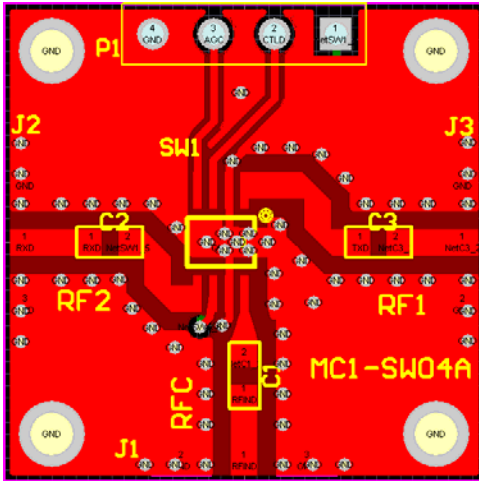

**MC1-SW04A Assembly Drawing:**

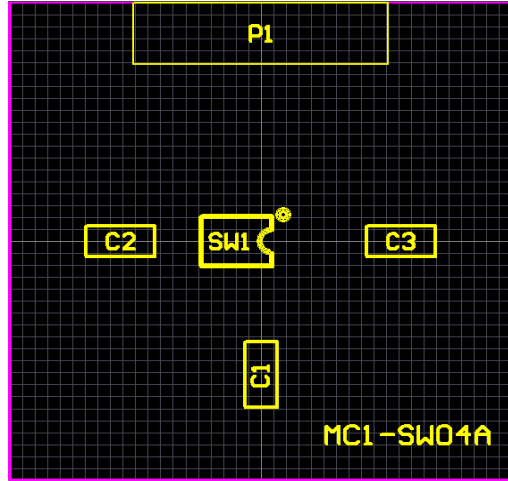

**Minimum supported devices and its vendors:**

Hittite: HMC546MS8G

**Bill of Material Example:**

Used	Part Type	Designator	Footprint
3	10PF	C1 C2 C3	0603
1	IO4	P1	P2_CON4_S
1	SW_HMC546MS8G	SW1	MS8G